



Kittitas County Office Of The Treasurer

Deanna Jo Panattoni, Treasurer

205 W. Fifth Suite #102

Ellensburg, Wa 98926

Phone (509) 962-7535 Fax (509) 933-8212

Cash Receipts

Receipt Number: 2009-2491 Date: 05/12/2009

Received From: COMMISSIONERS - MANDY

Check Amount: \$0.00

Cash Amount: \$500.00

Eft Amount: \$0.00

Total Amount: \$500.00

Deputy: janetw Receipt Type: CASH

Template:

Comments:

SUSPENSE RECEIPT 2009-1575 Administrative Appeal of Kittias County Community Development Services Conditions Placed upon O. Sieber Short Plat (SP-08-00052)James Denison Jr. on behalf of Otto Sieber

| <u>FundCode</u> | <u>GlCode</u> | <u>Description</u> | <u>Amount</u> |
|-----------------|---------------|--------------------|---------------|
| 001 | 1634589 | APPEALS FEE | \$500.00 |
| Total Amount: | | | \$500.00 |

Kittitas County Treasurer's Office

Submitted By: Janet Wilson

RECEIVED

MAY 12 2009

1st 2nd 3rd
KITTITAS COUNTY BOARD OF COMMISSIONERS

Lathrop, Winbauer, Harrel, Slothower & Denison L.L.P.

Attorneys at Law

Post Office Box 1088, 201 West Seventh Avenue, Ellensburg, WA 98926

F. Steven Lathrop, P.S.
John P. Winbauer
Susan K. Harrel
Jeff Slothower
James T. Denison, Jr.
Christopher P. Taylor

Tel (509) 925-6916
Fax (509) 962-8093

RECEIVED

MAY 12 2009

May 12, 2009

Kittitas County Board of County Commissioners
205 W 5th Ave., Suite 108
Ellensburg WA 98926

1st 2nd 3rd
KITTITAS COUNTY BOARD OF COMMISSIONERS

PA
CDS

Re: Administrative Appeal of Kittitas County Community Development Services
Conditions Placed upon O. Sieber Short Plat (SP-08-00052)

Dear Commissioners:

Please consider this letter Otto Sieber's (Landowner's) appeal of an administrative decision of the Kittitas County Community Development Services. Mr. Sieber's address is 470 Roza View Drive, Yakima, WA 98901. The administrative decision involves the O. Sieber Short Plat (SP-08-00052). A true and correct copy of the conditional approval of said short plat is attached hereto and incorporated herein by reference. Also submitted herewith is the \$500.00 appeal fee.

The basis of the appeal is that Kittitas County Community Development Services was in error by imposing condition No. 7 as a preliminary condition for approval. Condition No. 8 is sufficient to address any discovery of archeological artifacts, and condition No. 7 is an unnecessary expense. This particular property and surrounding area has been developed for various purposes over the years, with no indication of any probability items of archeological significance would be found on the platter ground. The landowner requests that Condition 7 be removed as a requirement for final approval.

The applicant requests the Board of County Commissioners schedule an appeal hearing on this appeal within the time required by law. I ask that any hearing be set AFTER June 24, 2009.

Very truly yours,

James T. Denison, Jr.

cc: Otto Sieber
Dave Nelson

F:\jd\jhsieber\sp appeal\letter to BOCC 5-12-09

COPY

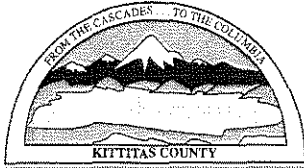

KITTTITAS COUNTY COMMUNITY DEVELOPMENT SERVICES

411 N. Ruby St., Suite 2, Ellensburg, WA 98926

CDS@CO.KITTTITAS.WA.US

Office (509) 962-7506

Fax (509) 962-7682

"Building Partnerships – Building Communities"

April 28, 2009

Otto Sieber
470 Roza View Drive
Yakima WA 98901

RE: O. Sieber Short Plat (SP-08-00052)

Dear Mr. Sieber:

The Kittitas County Community Development Services Department has determined that the O. Sieber Short Plat (SP-08-00052) is a complete application and hereby grants *conditional preliminary approval* subject to the following conditions:

1. Both sheets of the final mylars shall reflect short plat number SP-08-00052 and an accurate legal description shall be shown on the face of the final plat.
2. Full year's taxes must be paid on all tax parcel numbers per requirement of the Kittitas County Treasurer's Office.
3. The following plat notes shall be recorded on the final mylar drawings:
 - All development must comply with International Fire Code.
 - The subject property is within or near designated natural resource land of long-term commercial significance on which a variety of commercial activities may occur that are not compatible with residential development for certain periods of limited duration. (RCW 36.70A.060(1)) Commercial natural resource activities performed in accordance with county, state and federal laws are not subject to legal action as public nuisances. (RCW 7.48.305)
 - The approval of this division of land includes no guarantee that there is a legal right to withdraw groundwater within the land division. The approval of this division of land provides no guarantee that use of water under the ground water exemption (RCW 90.44.050) for this plat or any portion thereof will not be subject to curtailment by the Department of Ecology or a court of law.
 - The O Sieber Preliminary Plat No. SP-08-00052 currently has 5000 gallons of water per day for all domestic uses from the domestic well use exemption. According to WAC 173-539A each lot of the O. Sieber Plat is allowed no more than 1666 gallons per day per lot.
 - Metering shall be required on all new residential well connections and metering results shall be recorded in a manner consistent with Kittitas County and Washington State Department of Ecology requirements.
 - Kittitas County will not accept private roads for maintenance as public streets or roads until such streets or roads are brought into conformance with current County Road Standards. This requirement will include the hard surface paving of any street or road surfaced originally with gravel.
4. If distribution of the available water between parcels is different than listed above, specify the quantity of water in gallons per day by parcel on the final mylar.
5. Any ground water withdrawals in excess of 5,000 gallons per day or for the irrigation of more than 1/2 acre of lawn or noncommercial garden will require a permit from the Department of Ecology.

6. Chapter 173-150 WAC provides for the protection of existing rights against impairment, i.e. interruption or interference in the availability of water. If water supply in your area becomes limited your use could be curtailed by those with senior water rights.
7. Archaeological resources are protected under state law (RCW (27.53.060), (27.44.040), (27.44.055)). In order to protect the interests of all parties concerned, a cultural resource survey shall be conducted prior to final short plat approval by a *professional archaeologist* as defined by (RCW 27.53.030). The survey shall include background research, a pedestrian survey, and subsurface testing of the project area. The results of the survey shall be submitted by the applicant in a report to the County, who will then forward it to the Washington State Department of Archaeology and Historic Preservation (DAHP) and the Confederated Tribes and Bands of the Yakama Nation. The study and report must meet the DAHP professional standards and guidelines for survey and reporting. Based on the findings of the investigation, additional measures such as project redesign, archaeological monitoring and/or or data recovery may be required in order to protect or to mitigate damage to cultural resources if they cannot be avoided during any type of ground disturbing activities on the building lots that result from this short plat.
8. Should ground disturbing or other activities related to the proposed short plat result in the inadvertent discovery of cultural or archaeological materials, work shall be stopped in the immediate area and contact be made with the Washington State DAHP. Work shall remain suspended until the find is assessed and appropriate consultation is conducted. Should human remains be inadvertently discovered, as dictated by Washington State RCW 27.44.055, work shall be immediately halted in the area and contact made with the coroner and local law enforcement in the most expeditious manner possible.
9. Per Kittitas County Environmental Health, soil logs need to be performed and proof of water availability is needed. Evidence of both shall be provided to Community Development Services prior to final approval.
10. The addresses shall be clearly visible from both directions at the County Road for all properties.
11. The Fire Department access road shall be capable of supporting 75,000 lbs in all weather, be 20' wide, provide 13'6" vertical clearance and provide for adequate turn-around for fire department apparatus.
12. Please see the attached comments from Kittitas County Department of Public Works for plat notes and further issues that must be addressed prior to final approval.

Approval of the O. Sieber Short Plat may be appealed to the Kittitas County Board of Commissioners upon request of any aggrieved party within 10 working days, and shall accordingly be eligible for final administrative approval after May 13, 2009. Administratively approved short plats must be recorded with the County Auditor and shall not be deemed approved until so filed. If you have any questions, please do not hesitate to contact our office.

You may appeal this determination pursuant to KCC 15A.07.010 by submitting specific factual objections and a fee of \$500 to the Kittitas County Board of Commissioners (205 W. 5th, Room 108) by May 13, 2009 at 5:00p.m.

Sincerely,

Jeff Watson
Staff Planner

CC: Applicant
Required parties (KCC 15A)

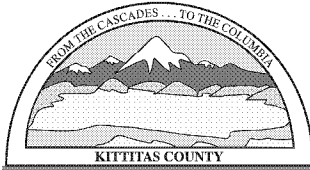

KITTITAS COUNTY COMMUNITY DEVELOPMENT SERVICES

411 N. Ruby St., Suite 2, Ellensburg, WA 98926

CDS@CO.KITTITAS.WA.US

Office (509) 962-7506

Fax (509) 962-7682

"Building Partnerships – Building Communities"

NOTICE OF APPLICATION

Date: January 8, 2009

To: Interested Departments & Agencies with Jurisdiction
Adjacent property owners (KCC 15A.03.060)
Applicant

From: Allison Kimball, Staff Planner

Subject: **O. Sieber Short Plat, SP-08-00052**

Please find enclosed a preliminary short plat drawing for the referenced short plat application. The application submitted by Encompass Engineering, authorized agent for Otto Sieber, landowner, was deemed complete on December 19, 2008. The proposal is a 3-lot short plat on approximately 17.65 acres of land that is zoned Ag-5, south of the City of Ellensburg, east of SR 821, north of Burbank Creek Road, off of Arrowhead Road, Ellensburg, WA 98926 and comprising a portion of Section, 21 and 22, T15N, R19E, WM, in Kittitas County. Assessor's map numbers 15-19-21000-0015 and 15-19-22000-0014.

The submitted application and related filed documents may be examined by the public at the Community Development Services office at 411 N Ruby Street, Suite 2, Ellensburg, WA 98926 as well as on the CDS website at www.co.kittitas.wa.us/cds/current/.

Comments on the overall application may be submitted to the Kittitas County Community Development Services Office, 411 N Ruby Street, Suite 2, Ellensburg, WA 98926, **before 5:00pm on Monday, January 26, 2009**. Staff Planner: Allison Kimball. Phone (509) 962-7506.

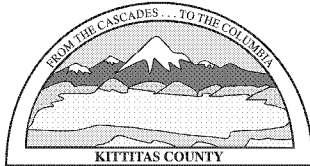

KITTITAS COUNTY COMMUNITY DEVELOPMENT SERVICES

411 N. Ruby St., Suite 2, Ellensburg, WA 98926

CDS@CO.KITTITAS.WA.US

Office (509) 962-7506

Fax (509) 962-7682

"Building Partnerships – Building Communities"

December 19, 2008

Otto Sieber
470 Roza View Drive
Yakima, WA 98901

RE: Determination of Complete Application
O. Seiber Short Plat (SP-08-00052)

To Whom It May Concern:

The referenced application for 3 lot Short Plat has been deemed complete as of December 19, 2008. Continued processing of your application will include, but is not limited to, the following actions:

1. A Notice of Application will be sent to all adjoining property owners within 500 feet of the subject property, interested persons, reviewing agencies and will be published in the official County newspaper of record.
2. Comments received during the comment period will be transmitted to you.
3. Conditional Preliminary Approval may be issued after the comment period has ended.

If you have any questions regarding this matter, please contact me at (509) 962-7506, or by e-mail to allison.kimball@co.kittitas.wa.us.

Sincerely,

Allison Kimball
Planner II

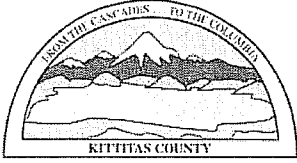

KITTITAS COUNTY COMMUNITY DEVELOPMENT SERVICES

411 N. Ruby St., Suite 2, Ellensburg, WA 98926

CDS@CO.KITTTITAS.WA.US

Office (509) 962-7506

Fax (509) 962-7682

SHORT PLAT APPLICATION

(To divide lot into 2-4 lots)

SP-08-00052

KITTITAS COUNTY ENCOURAGES THE USE OF PRE-APPLICATION MEETINGS. PLEASE CONTACT COMMUNITY DEVELOPMENT SERVICES TO SET UP A PRE-APPLICATION MEETING TO DISCUSS A PROPOSED PROJECT.

PLEASE TYPE OR PRINT CLEARLY IN INK. ATTACH ADDITIONAL SHEETS AS NECESSARY. PURSUANT TO KCC 15A.03.030, A COMPLETE APPLICATION IS DETERMINED WITHIN 28 DAYS OF RECEIPT OF THE APPLICATION SUBMITTAL PACKET AND FEE. THE FOLLOWING ITEMS MUST BE ATTACHED TO THE APPLICATION PACKET:

REQUIRED ATTACHMENTS

- Five large copies of short plat with all preliminary drawing requirements complete (reference KCC Title 16 Subdivision Code for plat drawing requirements) and one small 8.5"x11"copy.
- Address list of all landowners within 500 feet of the subject parcel(s). If adjoining parcels are owned by the applicant, then the 500 foot area shall extend from the farthest parcel. If the parcel is within a subdivision with a Homeowners' or Road Association, then please include the mailing address of the association.

OPTIONAL ATTACHMENTS

(Optional at submittal, required at the time of final submittal)

- Certificate of Title (Title Report)
- Computer lot closures

APPLICATION FEES:

\$190 plus \$10 per lot for Public Works Department;
\$380 plus \$75/hr. over 4 hrs. for Environmental Health Department;
\$630 for Community Development Services Department
(One check made payable to KCCDS)

FOR STAFF USE ONLY

APPLICATION RECEIVED BY:
(CDS STAFF SIGNATURE)

J. M. Groening

DATE:

11-19-08

RECEIPT #

3700



NOTES:

KITTITAS CO.
CDS

1. **Name, mailing address and day phone of land owner(s) of record:**

Landowner(s) signature(s) required on application form.

Name: OTTO SIEBER
Mailing Address: 470 ROZA VIEW DR
City/State/ZIP: YAKIMA, WA 98901
Day Time Phone: 509-457-0652
Email Address: _____

2. **Name, mailing address and day phone of authorized agent** (if different from land owner of record):

If an authorized agent is indicated, then the authorized agent's signature is required for application submittal.

Agent Name: _____
Mailing Address: _____
City/State/ZIP: _____
Day Time Phone: _____
Email Address: _____

3. **Street address of property:**

Address: ROZA VIEW DR
City/State/ZIP: Ellensburg, WA 98926

4. **Legal description of property:**

SEE ATTACHED

5. **Tax parcel number(s):** 234133 AND 084133

6. **Property size:** 6.40 AC. AND 11.25 AC. (acres)

7. **Narrative project description:** Please include the following information in your description: describe project size, location, water supply, sewage disposal and all qualitative features of the proposal; include every element of the proposal in the description (be specific, attach additional sheets as necessary):

This project will create 3 individual tax parcels ranging in size from 5.02 acres to 7.59 acres from 2 lots that total 17.65 acres. Each will have well and septic. The property is accessed from Hwy 97, Canyon Rd. and sits above the Yakima River.

8. **Are Forest Service roads/easements involved with accessing your development?**

Yes No (Circle) If yes, explain:

9. What County maintained road(s) will the development be accessing from?
HWY 97, CANYON ROAD

10. Application is hereby made for permit(s) to authorize the activities described herein. I certify that I am familiar with the information contained in this application, and that to the best of my knowledge and belief such information is true, complete, and accurate. I further certify that I possess the authority to undertake the proposed activities. I hereby grant to the agencies to which this application is made, the right to enter the above-described location to inspect the proposed and or completed work.

All correspondence and notices will be mailed to the Land Owner of Record and copies sent to the authorized agent.

Signature of Authorized Agent: _____ Date: _____
(REQUIRED if indicated on application)

X _____

Signature of Land Owner of Record: _____ Date: _____
(REQUIRED for application submittal)

X  _____ 10/29/08

O. SIEBER SHORT PLAT
 PORTION OF THE E 1/2 OF THE SE 1/4 OF SECTION 21 AND A
 PORTION OF THE W 1/2 OF THE SW 1/4 OF SECTION 22,
 TOWNSHIP 15 NORTH, RANGE 19 EAST, W.M.
 KITITAS COUNTY, WASHINGTON

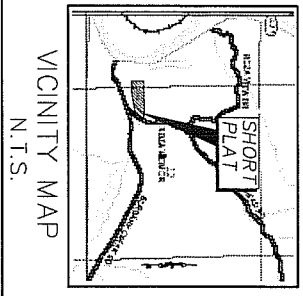

APPROVALS

KITITAS COUNTY PUBLIC WORKS

EXAMINED AND APPROVED This ____ day of _____ A.D. 20 ____

Kititias County Engineer

COUNTY PLANNING DIRECTOR

I hereby certify that the O. Sieber Short Plat has been examined by me and find that it conforms to the Comprehensive Plan of the Kititias County Planning Commission.

Dated this ____ day of _____ A.D. 20 ____

Kititias County Planning Director

KITITAS COUNTY HEALTH DEPARTMENT

Preliminary inspection indicated soil conditions may allow use of septic tanks as a temporary measure until a permanent septic system is installed. Prospective purchasers of lots are urged to make inquiries of the County Health Department about issuance of septic tank permits for lots.

Dated this ____ day of _____ A.D. 20 ____

Kititias County Health Officer

CERTIFICATE OF COUNTY TREASURER

I hereby certify that the taxes and assessments on the above described land for the year 2008 are as follows:

Dated this ____ day of _____ A.D. 20 ____

Kititias County Treasurer

RECORDER'S CERTIFICATE

Filed for record this ____ day of _____ 20 ____ at _____ M in book _____ of _____ at page _____ at the request of

DAVID P. NELSON
 Surveyor's Name

County Auditor Deputy County Auditor

| LINE | BEARING | DISTANCE |
|------|-------------|----------|
| L1 | S00°08'09"E | 61.57 |
| L2 | S00°08'09"E | 54.58 |
| L3 | S88°43'16"W | 70.00 |
| L31 | N12°05'51"E | 74.43 |
| L32 | S77°54'09"E | 50.00 |
| L33 | S12°05'51"W | 106.17 |

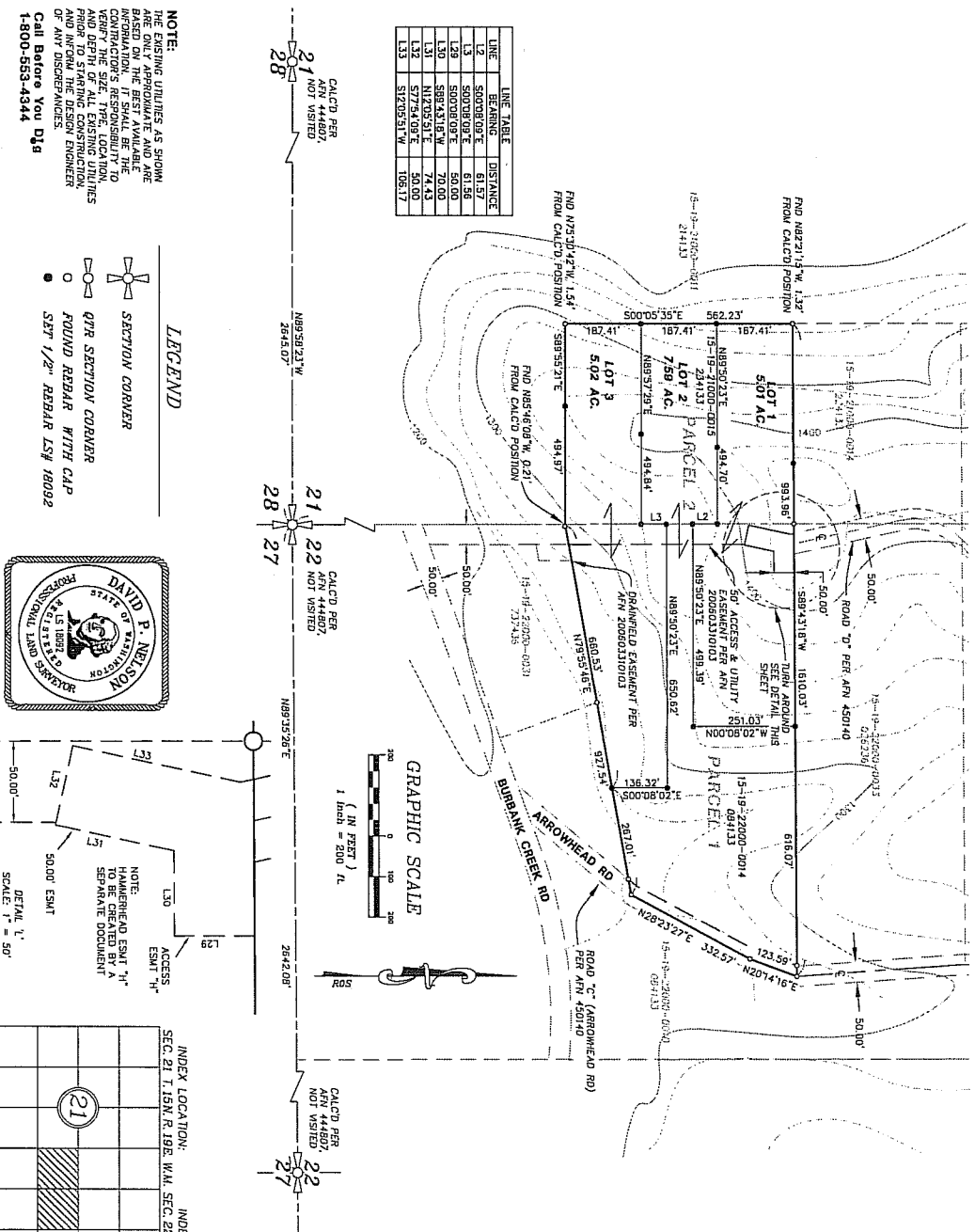

SURVEYOR'S CERTIFICATE

This map correctly represents a survey made by me or under my direction in conformance with the requirements of the Survey Recording Act at the request of _____.

DAVID P. NELSON
 DATE
 Certificate No. 18092

Encompass
 ENGINEERING & SURVEYING

108 EAST 2ND STREET
 CLE ELUM, WA 98922
 PHONE: (509) 674-7433
 FAX: (509) 674-7419

| OWN BY | DATE | JOB NO. |
|-----------|---------|---------|
| CHAD BY | 11/2008 | 08123 |
| D. NELSON | | |

SCALE 1"=200'

SHEET 1 OF 2

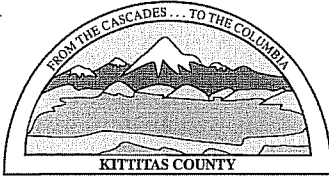

KITITAS COUNTY

DEPARTMENT OF PUBLIC WORKS

MEMORANDUM

TO: Community Development Services
FROM: Christina Wollman, Planner II *W*
DATE: April 1, 2009
SUBJECT: O. Sieber Short Plat SP-08-00052

Our department has reviewed the short plat application and has the following comments:

- “Conditional Preliminary Approval”** is recommended based on the information provided. See below for conditions of preliminary approval.
- “Additional Information Requested”**. Prior to continuing the approval process for the submitted development, additional information is requested for analysis.
-

The following shall be conditions of preliminary approval:

1. Timing of Improvements: This application is subject to the latest revision of the Kittitas County Road Standards, dated 9/6/05. The following conditions apply and must be completed prior to the issuance of a building permit for any of the residence within this plat. A Performance Bond or acceptable financial guarantee may be used, in lieu of the required improvements, per the conditions outlined in the current Kittitas County Road Standards.
2. Private Road Certification: Private roads serving any of the lots within this development shall be inspected and certified by a licensed professional engineer for conformance with current Kittitas County Road Standards, 9/6/05 edition. Kittitas County Public Works shall require this road certification to be completed prior to the issuance of a building permit for any of the structures within the proposed plat.
3. Easement Width: All access easements within this plat are required to be 60'. Documentation was submitted to Public Works stating the easements are 60'. This shall be reflected on the final plat.
4. Hammerhead: The note stating the hammerhead easement will be created by a separate document shall be removed. The hammerhead shall be constructed as required by the 2006 International Fire Code.

5. Private Road Improvements: All access shall be constructed to meet or exceed the requirements of a Low-Density Private Road. See Kittitas County Road Standards, 9/6/05 edition.

If Burbank Creek Road is designated as the primary access to this short plat, a second access is required. The second access, Rosa View Drive, shall also be constructed to meet or exceed the conditions of a Low-Density Private Road.

If Rosa View Drive is designated as the primary access to this short plat, a second access is not required.

- a. Access easements shall be a minimum of 60' wide. The roadway shall have a minimum width of 20', with 1' shoulders, for a total width of 22'.
 - b. Minimum centerline radius will be 60'.
 - c. The surface requirement is for a minimum gravel surface depth of 6".
 - d. Maximum grade is 12%.
 - e. Stopping site distance, reference AASHTO.
 - f. Entering site distance, reference AASHTO.
 - g. Maintenance of driveway approaches shall be the responsibility of the owner whose property they serve. The County will not maintain accesses.
 - h. Any further subdivision or lots to be served by proposed access may result in further access requirements.
 - i. All roads located within this development or roads that provide access to this development shall be constructed to current county road standards unless any other maintenance agreements, forest service road easements or state easements require higher road standards. The higher of the road standards shall apply.
 - j. All easements shall provide for AASHTO radius at the intersection of county road.
 - k. A paved apron shall be constructed at the intersection of the proposed private intersection and the county road right of way.
6. Private Road Maintenance Agreement: The applicant shall meet all applicable conditions of any pre-established or required Private Road Maintenance Agreements.
7. Lot Closure: It is the responsibility of the Professional Licensed Surveyor (PLS) to ensure the lot closures are correct and accurate.
8. Access Permit: An approved access permit shall be required from the Department of Public Works prior to creating any new driveway access or performing work within the county road right of way.
9. Addressing: Contact the Kittitas County Rural Addressing Coordinator at (509) 962-7523 to obtain addresses prior to obtaining a building permit. A parcel cannot receive a building permit or utilities until such parcel is identified with a 911 address.

10. Mailbox Placement: The U.S. Postal Service requires that private roads with 6 or more residences install USPS approved Cluster Box Units (CBUs) at a safe location at the mouth of the private road. Contact your local Post Office for location and additional design requirements before beginning construction.

Current Kittitas County Road Standards, as adopted 9/6/05.

Chapter 12 – PRIVATE ROADS

12.12.010 General

Private roads shall meet the following conditions:

1. Private roads shall meet the minimum access requirements of the International Fire Code as adopted by the County, and
2. Shall be designed and constructed in conformance with AASHTO Guidelines for Geometric Design of Very Low-Volume Local Roads (ADT < 400) 2001, as now exists or hereafter amended, and
3. Shall be inspected and certified by a licensed professional engineer for conformance with the above referenced standards. In the alternative, an applicant may request the private roadway to be inspected and subject to the approval of the Public Works Director. If certification by the public Works Director/County Engineer is desired, submission of road plans and necessary testing documentation that confirms compliance with Kittitas County Road Standards is required, and services will be performed on a reimbursable basis, and
4. Permanently established by an easement recorded with the Kittitas County Auditor or right-of-way, providing legal access to each affected lot, dwelling unit, or business, and
5. Will not result in land locking of existing or proposed parcels, and
6. Maintained by the developer or legally responsible owner or homeowners' association or other legal entity made up of all benefited property owners, under the provisions of an acceptable and recorded "Private Road Maintenance Agreement", and
7. Clearly described on the face of the plat, short plat, or other development authorization and clearly signed at street location as a private street or road, for the maintenance of which Kittitas County is not responsible and a disclosure statement of the same is filed with the County Auditor, and
8. The following note shall be placed on the face of the plat, short plat, or other development authorization:

"Kittitas County will not accept private roads for maintenance as public streets or roads until such streets or roads are brought into conformance with current County Road Standards. This requirement will include the hard surface paving of any street or road surfaced originally with gravel."

Please let me know if you have any questions or need further information.

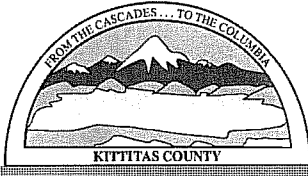

KITTITAS COUNTY COMMUNITY DEVELOPMENT SERVICES

411 N. Ruby St., Suite 2, Ellensburg, WA 98926

CDS@CO.KITTITAS.WA.US

Office (509) 962-7506

Fax (509) 962-7682

"Building Partnerships – Building Communities"

MEMORANDUM

DATE: March 30, 2009

TO: Christina Wollman

FROM: Allison Kimball

RE: O. Sieber Short Plat (SP-08-00052)

Attached please find the documentation submitted by Dave Nelson regarding the 60' easement for the O. Sieber Short Plat.

Thank you.

01564
Sieber
450100

RECEIVED

MAR 27 2009

KITTITAS COUNTY AUDITOR
FILED REQUEST OF:
Burbank Creek Partnership
'81 MAR 6 PM 2:10
Kittitas County
CDS

ACCESS AND UTILITIES EASEMENTS

BURBANK CREEK PROJECT

THIS AGREEMENT made this 5th day of March, 1981, by and between EMILE L. ROBERT, JR. and VICTOR E. ROBERT, "First Parties", and BURBANK CREEK LIMITED PARTNERSHIP, "Second Party":

W I T N E S S E T H:

WHEREAS, First and Second Parties are the owners of property within Sections 15, 21, 22, 23 and 26, Township 15 North, Range 19 E.W.M., in Kittitas County, Washington; and,

WHEREAS the parties have developed access and utilities easements over and across strips of land sixty (60) feet in width for the benefit of the First and Second Parties and their assigns; and

WHEREAS, the First and Second Parties wish to enter into and execute the within Easement Agreement for the protection of said parties and for the protection of those who have purchased from them or who will in the future purchase from them.

NOW, THEREFORE, for and in consideration of the mutual covenants and conditions contained herein, it is hereby agreed as follows:

1. First and Second Parties do hereby give, grant and convey to themselves and to those parties who have purchased tracts within the Burbank Creek Project or over and through which the existing roadways pass, an access and utility easement sixty (60) feet in width as described and set forth in the roadway grid attached hereto and marked Exhibit "A" and more fully described in Exhibit "B" which contains the legal description for roads A, B, C, D, E, F, H, I, J and K.

2. It is specifically understood that the Access and Utility Easements set forth in the road grid attached as Exhibit "A" and described in Exhibit "B" shall comprise an easement over and across a strip of land sixty (60) feet in width, being thirty (30) feet on both sides of the described centerlines.

EXECUTED on the day and year first above written.

SECOND PARTY:
BURBANK CREEK LIMITED
PARTNERSHIP:

By: [Signature]
General Partner

FIRST PARTIES:

[Signature]
EMILE L. ROBERT, JR.

[Signature]
VICTOR E. ROBERT

Access & Utilities Easement

LAW OFFICES OF
DOUGLAS A. WILSON
AND
GERALD L. MIKESSELL
SUITE 2, YAKIMA LEGAL CENTER
303 EAST "D" STREET
YAKIMA, WASHINGTON 98901
(509) 748-6473

EXHIBIT "B"

BURBANK CREEK PROJECT

The following are the legal descriptions of the roadways within the Burbank Creek Project, within Sections 15, 21, 22, 23, and 26, Township 15 North, Range 10 East of the Willamette Meridian, Kittitas County, Washington.

Access and utility easements over and across strips of land ~~60.00~~^{60.00} feet in width, being ~~30.00~~^{30.00} feet on both sides of the following described centerlines:

ROAD "A"

Beginning at the Northwest corner of Section 22, Township 15 North; Range 19 East; W.M.; thence South $0^{\circ}03'$ East along the West line of said Section 2640.80 feet to the West Quarter corner of said Section 22; thence South $23^{\circ}41'41''$ West 1973.05 feet to the Easterly right of way line of the State Highway and the true point of beginning; thence South $70^{\circ}57'21''$ East 314.22 feet; thence North $85^{\circ}21'14''$ East 234.40 feet; thence North $35^{\circ}02'17''$ East 156.44 feet; thence North $69^{\circ}50'13''$ East 1053.70 feet; thence along the arc of a curve to the right having a central angle of $24^{\circ}26'13''$, a radius of 1154.51 feet and a chord bearing and distance North $82^{\circ}03'07''$ East 488.80 feet; thence South $85^{\circ}43'34''$ East 589.67 feet; thence North $64^{\circ}35'27''$ East 853.56 feet; thence along the arc of a curve to the right, having a central angle of $39^{\circ}07'28''$, a radius of 281.42 feet and a chord bearing and distance of North $84^{\circ}09'12''$ East 188.46 feet; thence South $76^{\circ}17'05''$ East 454.21 feet; thence South $61^{\circ}46'15''$ East 690.00 feet; thence South $62^{\circ}15'54''$ East 817.29 feet; thence South $55^{\circ}02'45''$ East 782.67 feet; thence South $62^{\circ}09'05''$ East 1513.15 feet; thence South $35^{\circ}42'09''$ East 682.65 feet; thence South $48^{\circ}12'00''$ East 1035.67 feet; thence South $50^{\circ}42'29''$ East 213.76 feet to the East line of the West Half of Section 26, Township 15 North; Range 19 East; W.M. and the terminus of said ROAD "A".

ROAD "B"
 Beginning at the North Quarter corner of Section 26, Township 15
 North; Range 19 East; W.M.; thence South 0°31'18" East along the
 East line of the Northwest Quarter of said Section 26 2078.32
 feet to the true point of beginning; thence North 55°38'42" West
 266.40 feet to the terminus of said ROAD "B".

ROAD "C"

Beginning at the Northwest corner of Section 22, Township 15 North; Range 19 East; W.M.; thence South $0^{\circ}03'$ East along the West line of said Section 2640.80 feet to the West Quarter corner of said Section 22; thence South $24^{\circ}26'43''$ East 1599.21 feet to the true point of beginning; thence North $40^{\circ}07'11''$ East 395.07 feet; thence North $28^{\circ}23'27''$ East 332.57 feet; thence North $20^{\circ}14'06''$ East 123.59 feet; thence North $4^{\circ}04'50''$ West 415.62 feet; thence North $4^{\circ}36'43''$ East 251.88 feet; thence North $49^{\circ}55'01''$ East 150.30 feet; thence North $13^{\circ}04'22''$ East 230.71 feet; thence North $37^{\circ}32'44''$ East 205.67 feet; thence North $0^{\circ}50'49''$ East 63.48 feet; thence North $68^{\circ}21'54''$ East 479.67 feet; thence North $55^{\circ}11'52''$ East 159.55 feet; thence North $33^{\circ}34'07''$ East 189.06 feet; thence North $53^{\circ}39'27''$ East 232.93 feet; thence North $28^{\circ}04'23''$ East 260.32 feet; thence North $22^{\circ}35'$ East 196.00 feet; thence North $72^{\circ}43'$ East 164.00 feet; thence North $68^{\circ}45'$ East 495.00 feet; thence North $24^{\circ}46'$ East 236.00 feet; thence North $49^{\circ}30'$ East 545.00 feet; thence North $76^{\circ}29'$ East 196.00 feet; thence North $58^{\circ}00'$ East 115.00 feet; thence North $33^{\circ}39'$ East 394.00 feet to the terminus of said ROAD "C"

15 May 178

ROAD "D"

Beginning at the Northwest corner of Section 22, Township 15 North; Range 19 East; W.M.; thence South $0^{\circ}03'$ East along the West line of said Section 2640.80 to the West Quarter corner of said Section 22; thence North $71^{\circ}30'55''$ East 1477.60 feet to the true point of beginning; thence South $68^{\circ}22'$ West 234.24 feet; thence North $32^{\circ}22'$ West 172.39 feet; thence North $79^{\circ}13'$ West 158.16 feet; thence North $68^{\circ}00'$ West 207.00 feet; thence South $77^{\circ}30'$ West 164.00 feet; thence South $62^{\circ}10'$ West 252.00 feet; thence South $42^{\circ}59'$ West 214.00 feet; thence South $9^{\circ}06'$ West 570.00 feet; thence South $41^{\circ}05'$ West 151.45 feet; thence along the arc of a curve to the left having a central angle of $53^{\circ}28'$, a radius of 150.00 feet and a chord bearing and distance of South $14^{\circ}21'$ West 134.95 feet; thence South $12^{\circ}23'$ East 354.00 feet to the terminus of said ROAD "D".

Beginning at the East Quarter corner of Section 22, Township 15
 North, Range 19 East; W.M. thence South 0°12'31" West along the
 East line of said Section 22 2623.31 feet to the Southeast
 corner thereof; thence North 57°30'55" West 2984.39 feet;
 thence North 33°08'49" East a distance of 157.20 feet; thence
 North 27°25'53" East a distance of 305.64 feet; thence North
 13°12'54" East a distance of 388.69 feet; thence North 39°01'06"
 East a distance of 141.34 feet; thence North 53°21'19" East a
 distance of 187.64 feet; thence North 77°35'39" East a distance
 of 499.53 feet; thence North 85°34'18" East a distance of 258.84
 feet; thence North 71°16'09" East a distance of 220.12 feet;
 thence North 57°21'49" East a distance of 415.91 feet to the
 terminus of said ROAD "E"

ROAD "F"
Beginning at the East Quarter corner of Section 22, Township 15
North; Range 19 East; W.M. thence South 0°12'31" West along the
East Line of said Section 22 2623.31 feet to the Southeast
corner thereof; thence North 49°42'54" West 1726.00 feet;
thence South 0°00'20" West a distance of 557.36 feet to the
terminus of said ROAD "F".

ROAD "B"

Beginning at the Northwest corner of Section 22, Township 15 North, Range 19 East; W.M.; thence South $0^{\circ}03'$ East along the West line of said Section 2640.80 feet to the West Quarter corner of said Section 22; thence North $59^{\circ}13'44''$ East 1089.36 feet to the true point of beginning; thence North $9^{\circ}58'$ East 320.00 feet; thence North $2^{\circ}09'$ West 126.00 feet; thence North $9^{\circ}54'$ East 252.00 feet; thence North $46^{\circ}19'$ West 316.00 feet; thence North $20^{\circ}07'$ West 243.00 feet; thence North $22^{\circ}28'$ West 320.00 feet; thence South $80^{\circ}57'$ West 778.00 feet; thence North $77^{\circ}23'$ West 188.00 feet; thence South $66^{\circ}25'$ West 349.00 feet; thence North $69^{\circ}02'$ West 416.00 feet; thence South $57^{\circ}24'$ West 273.00 feet; thence South $81^{\circ}34'$ West 256.87 feet; thence along the arc of a curve to the left having a central angle of $88^{\circ}54'$ and a radius of 100.00 feet and a chord bearing and distance of South $37^{\circ}07'$ West 140.06 feet; thence South $7^{\circ}20'$ East 192.23 feet; thence South $54^{\circ}05'$ East 290.00 feet; thence South $72^{\circ}11'$ West 483.40 feet to the centerline of the State Highway and the terminus of said ROAD "B".

ROAD "1"
Beginning at the Northwest corner of Section 22, Township 15
North, Range 19 East; W.M.; thence South 0°07' East along the
West line of said Section 2640.80 feet to the West Quarter
corner of said Section 22; thence North 5°17'14" West 1874.40
feet to the true point of beginning; thence North 3°09' West
285.65 feet; thence along the arc of a curve to the left
having a central angle of 11°04', a radius of 80.00 feet and
a chord bearing and distance of North 60°11' West 134.24 feet;
thence South 62°47' West 110.60 feet to the terminus of said
ROAD "1".

ROAD "J"

Beginning at the Northwest corner of Section 22, Township 15 North; Range 19 East; W.M.; thence South $0^{\circ}03'$ East along the West line of said Section 2640.80 feet to the West Quarter corner of said Section 22; thence North $59^{\circ}41'40''$ East 2858.87 feet; thence North $6^{\circ}23'$ West 521.00 feet; thence North $35^{\circ}00'$ West 413.2 feet; thence along the arc of a curve to the right having a central angle of $52^{\circ}00'$, a radius of 180.00 feet and a chord bearing and distance of North $9^{\circ}00'$ West 157.81 feet; thence North $17^{\circ}00'$ East 213.2 feet; thence North $8^{\circ}59'$ East 71.00 feet; thence North $20^{\circ}07'$ West 95.00 feet; thence North $54^{\circ}12'$ East 211.00 feet; thence North $44^{\circ}17'$ East 323.00 feet; thence North $57^{\circ}38'$ East 104.00 feet; thence North $64^{\circ}24'$ East 265.00 feet; thence North $56^{\circ}19'$ East 249.00 feet; thence North $31^{\circ}41'$ East 434.00 feet; thence North $53^{\circ}54'$ East 61.00 feet; thence South $81^{\circ}46'$ East 124.00 feet; thence South $45^{\circ}55'$ East 104.00 feet; thence South $17^{\circ}45'$ East 603.00 feet; thence South $6^{\circ}42'$ East 166.00 feet; thence South $0^{\circ}04'$ West 116.00 feet; thence South $15^{\circ}02'$ East 277.00 feet; thence South $2^{\circ}35'$ East 223.00 feet; thence South $27^{\circ}50'$ West 78.00 feet; thence South $36^{\circ}12'$ West 64.00 feet; thence South $62^{\circ}25'$ West 165.87 feet; thence South $76^{\circ}29'$ West 60.66 feet to the terminus of said ROAD "J".

ROAD "K"

Beginning at the northwest corner of Section 22, Township 15 North, Range 19 East, W.M.; thence South $0^{\circ}03'$ East along the West line of said Section 2640.80 feet to the West Quarter corner of said Section 22; thence North $16^{\circ}40'18''$ East 2076.07 feet to the true point of beginning; thence North $25^{\circ}26'$ East 236.00 feet; thence North $42^{\circ}06'$ East 590.00 feet; thence North $48^{\circ}51'$ East 251.00 feet; thence North $79^{\circ}41'$ East 610.00 feet; thence South $72^{\circ}39'$ East 322.38 feet to the terminus of said ROAD "K"

ALL SECTIONS IN COLOURS WITH
WITH SOLID BLACK CIRCLES WITH
FOUND. ALL OTHERS WERE CALLED

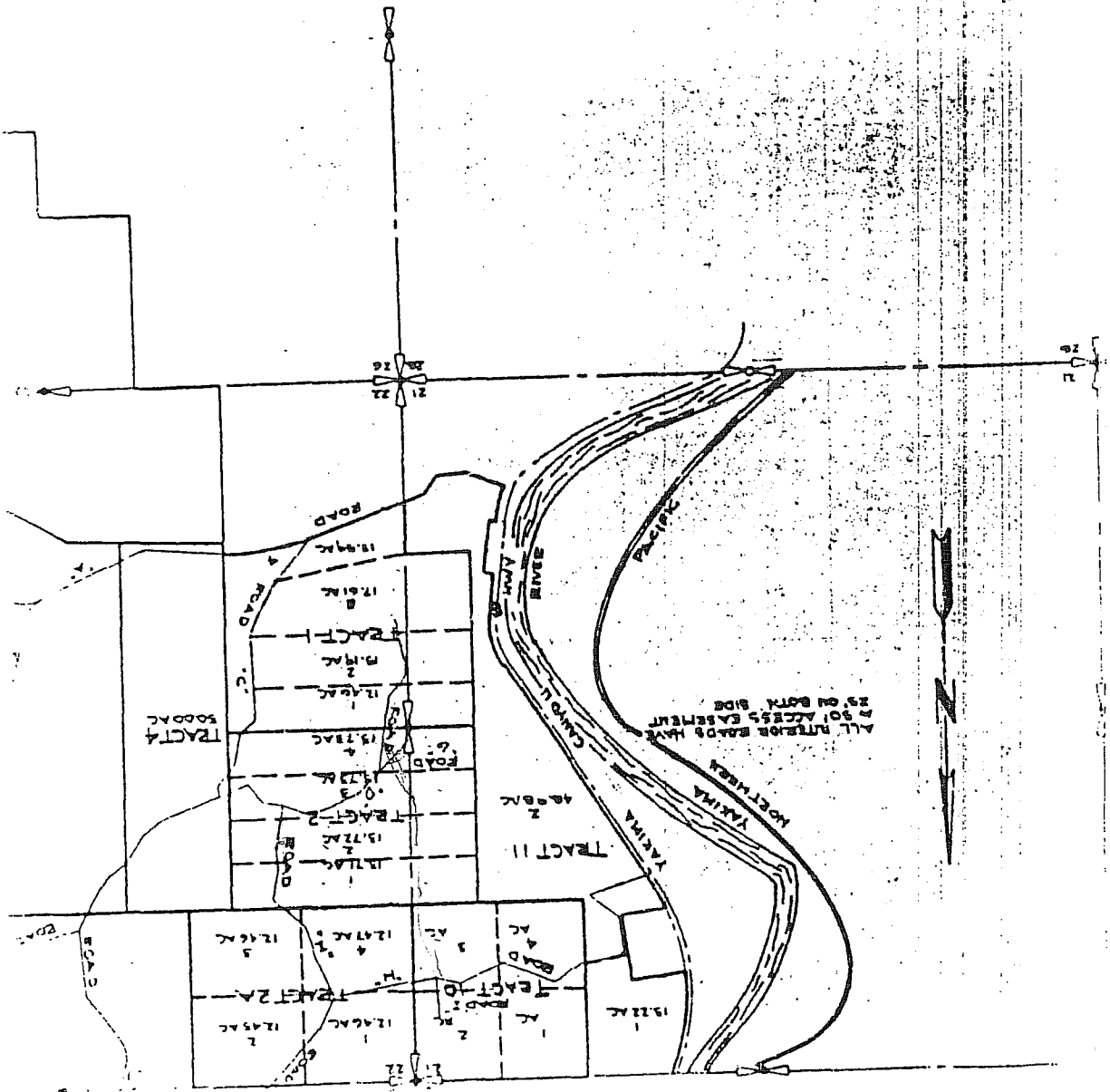

ROY ALISAMPLE & L
 DISTRICT SEC. 22, T8, R26, N17
 PARCEL

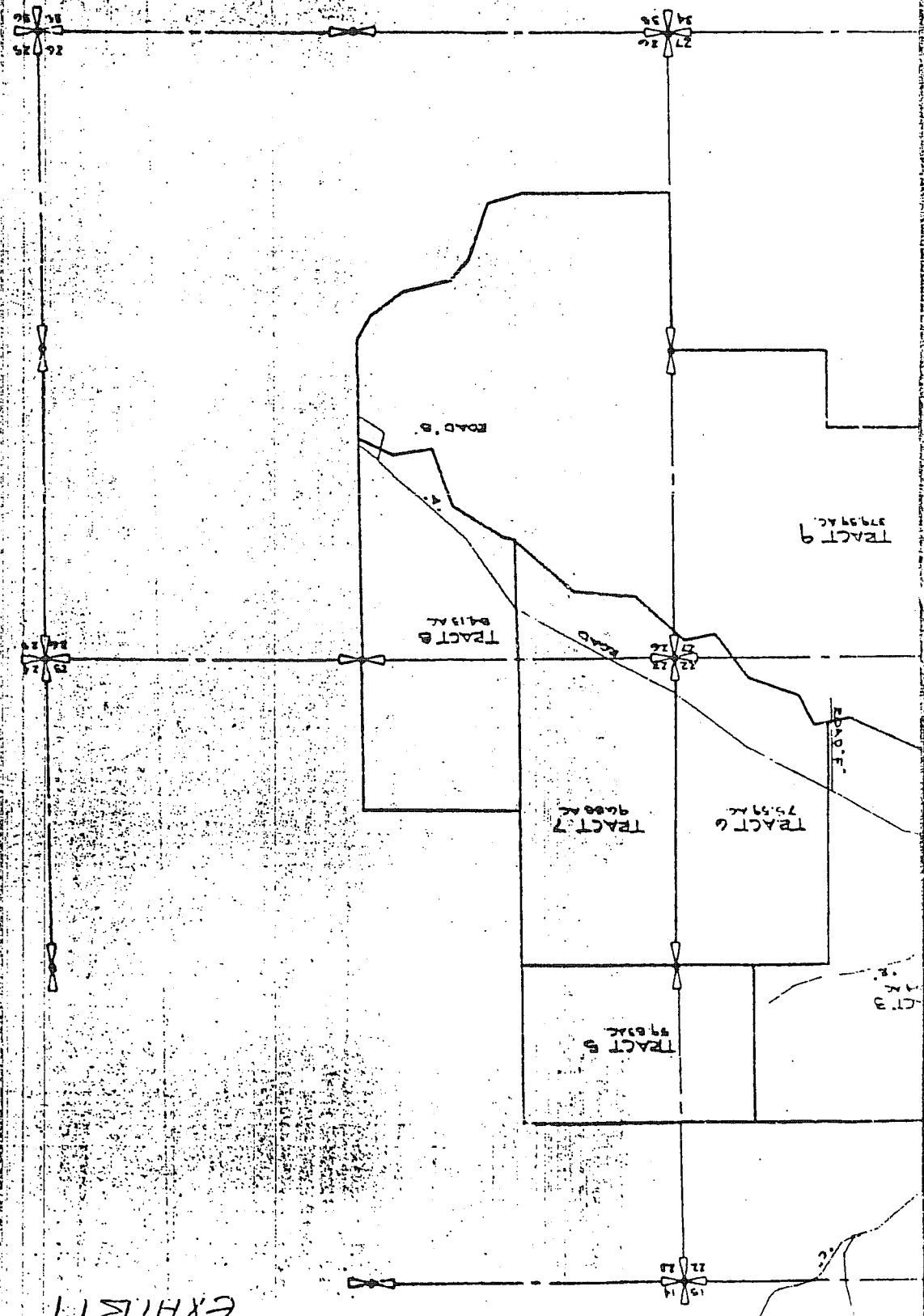

EXHIBIT "A"

FORDON CREEK LIMITED PARTNERSHIP
 1410 N. 10th AVE. YAKIMA, WA

Otto Sieber

From: "Otto Sieber" <hardhatphoto@dishmail.net>
To: <allison.kimball@co.kititas.wa.us>
Sent: Tuesday, March 24, 2009 11:06 AM
Subject: Yakima Nation comments

Hi Allison,

Regarding the comments from Yakima Nation you forwarded on January 14, I apologies fro not responding. Dave Nelson is handling the matter for me and he informed me that Noah Goodrich and he(Nelson) ,had a long discussion with you and I did not need to respond.

The material you forwarded to me did not indicate I need to respond.

The site in question was developed by Larson Orchard into 20 ac. lots in the 80s--there are roads, power lines and other excavations. The precise location of of the proposed building site was a large rock quarry that was extensively developed back then. We do not intend to do anything outside of the areas that has already been developed/ disturbed.

Regards



Otto

RECEIVED
MAR 28
KITITAS COUNTY
ODS

Allison Kimball

From: James Rivard
Sent: Wednesday, February 04, 2009 11:14 AM
To: Allison Kimball
Subject: Take 5 Plat and O. Sieber Short Plat - Soil logs done

Soil logs complete and Ok. They both need water information.

James Rivard
Environmental Health Specialist II
Kittitas County Public Health Department
411 N. Ruby St., Suite 3
Ellensburg, WA 98926
(509) 962-7005

CONFIDENTIALITY NOTICE: This e-mail message and any attachments are for the sole use of the intended recipient(s) and may contain proprietary, confidential or privileged information. Any unauthorized review, use, disclosure or distribution is prohibited and may be a violation of law. The enclosed information may or may not be accurate and the recipient of such information understands this fact in its entirety. If you are not the intended recipient or a person responsible for delivering this message to an intended recipient, please contact the sender by reply e-mail and destroy all copies of the original message.



KITTITAS COUNTY FIRE MARSHAL'S OFFICE

411 N. Ruby St., Suite 2, Ellensburg, WA 98926
Office (509) 962-7000
Fax (509) 962-7682

January 30, 2009

Allison Kimball
Staff Planner
411 N. Ruby Street, Suite 2
Ellensburg, WA 98926

Re: O. Sieber Short Plat, SP-08-00052

Dear Ms. Kimball:

After conducting a pre-review of the above named project, I have the following comments:

- Access requirements shall be per the 2006 International Fire Code Appendix D as well as Kittitas County Road Standards. A copy of the Kittitas County Road Standards may be obtained by contacting Kittitas County Public Works. 509-962-7523.
- All development must comply with the 2006 International Fire Code.

Any questions or concerns regarding fire service features may be directed to the Kittitas County Fire Marshal's Office. 509-962-7000.

Sincerely,

A handwritten signature in cursive script that reads "Brenda Larsen".

Brenda Larsen
Fire Marshal

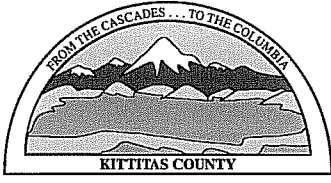

KITTITAS COUNTY

DEPARTMENT OF PUBLIC WORKS

MEMORANDUM

TO: Allison Kimball, CDS
FROM: Christina Wollman, Planner II *aw*
DATE: January 28, 2009
SUBJECT: REQUEST FOR MORE INFORMATION
O. Sieber Short Plat SP-08-00052
Take Five Plat LP-08-00032

Prior to conditional approval of the O. Sieber Short Plat and Take Five Plat, the Kittitas County Department of Public Works requests the following information:

Documentation of a 60' access easement to all tax lots in both projects.

Kittitas County Road Standards require that all access easements in these projects be a minimum of 60' (KCRS, 9/6/05 edition, Table 12-1, Low-Density Private Road).

Kittitas County Department of Public Works will grant conditional approval after this information is received. Please contact me if you have any questions.



STATE OF WASHINGTON
DEPARTMENT OF ECOLOGY

15 W Yakima Ave, Ste 200 • Yakima, WA 98902-3452 • (509) 575-2490

January 23, 2009

Allison Kimball
Kittitas Community Development Services
411 N. Ruby Street, Suite 2
Ellensburg, WA 98926

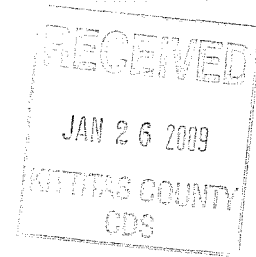

Dear Ms. Kimball:

Thank you for the opportunity to comment on the short plat of approximately 17.65 acres into 3 lots, proposed by Otto Sieber [SP-08-00052]. We have reviewed the application and have the following comments.

Water Resources

Any ground water withdrawals in excess of 5,000 gallons per day or for the irrigation of more than ½ acre of lawn or noncommercial garden will require a permit from the Department of Ecology.

Chapter 173-150 WAC provides for the protection of existing rights against impairment, i.e. interruption or interference in the availability of water. If water supply in your area becomes limited your use could be curtailed by those with senior water rights.

The Attorney General's Opinion, (AGO 1997 No. 6) regarding the status of exempt ground water withdrawals, states that a group of wells drilled by the same person or group of persons, at or about the same time, in the same area, for the same purpose or project should be considered a single withdrawal and would not be exempt from the permitting requirement contained in RCW 90.44.050, if the total amount withdrawn for domestic use exceeds 5,000 gallons per day or if a total of more than .5 acre of lawn and garden are irrigated.



Ms. Kimball
January 23, 2009
Page 2 of 2

The Attorney General's opinion suggests that caution should be used in finding developments to be exempt from needing a water right permit if the possibility exists that the development of the project will result in the ultimate withdrawal of water in excess of 5,000 gallons per day or the irrigation of more than .5 acre of lawn and garden.

This application is subject to WAC 173-539A. Source meter(s) must be installed at the point(s) of withdrawal in compliance with WAC 173-173-100. **Metering and reporting will be required** in compliance with 173-539A-070.

The Department of Ecology encourages the development of public water supply systems, whether publicly or privately owned, to provide water to regional areas and developments.

If you have any questions concerning the Water Resources comments, please contact Breean Zimmerman at (509) 454-7647.

Sincerely,

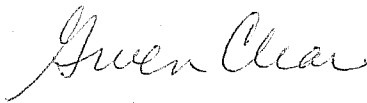

Gwen Clear
Environmental Review Coordinator
Central Regional Office
(509) 575-2012



To Protect and Promote the Health and the Environment of the People of Kittitas County

January 21, 2009

Allison Kimball, Staff Planner
Community Development Services
411 N Ruby Street, Suite 2
Ellensburg, WA 98926

RECEIVED

JAN 22 2009

Kittitas County
CDS

Dear Ms. Kimball,

Thank you for the opportunity to comment on the O. Sieber Short Plat, SP-08-00052. Pursuant to the Memorandum of Agreement between Kittitas County and the Washington State Department of Ecology all the future residential well connections serving the proposed lots shall be required to have meters installed. Metering results shall be recorded in a manner consistent with Kittitas County and Washington State Department of Ecology requirements.

The developer/owner of the plat must provide proof of water availability before the Public Health Department will recommend plat approval. Water availability can be provided through several different ways depending on the source of water proposed.

If a public water system is proposed for the plat, the public water system information shall be submitted, reviewed, and approved by Kittitas County Public Health Department or Washington State Department of Health which includes final issuance of the well ID number to meet the water availability requirement for plat approval.

If individual wells or shared wells are proposed for the parcels and there is an existing well located on the plat, a well log from Washington State Department of Ecology will meet the water availability requirement. If there is not an existing well on the plat, then a water availability report with documentation and evidence to support the claim regarding adequate availability of groundwater for the proposed number of potable water wells must be submitted for review.

The developer/owner of the plat shall provide soil logs according to WAC 246-272A-0220 or as amended which includes a minimum of one test hole per parcel. Kittitas County Public Health Department shall determine if additional test holes will be required for recommendation of final plat approval. The purpose of a soil log is to ensure that future property owners can be assured that they will be able to

Kittitas County
Public Health Department
507 N. Nanum Street, Suite 102
Ellensburg, WA 98926
T: 509.962.7515
F: 509.962.7581

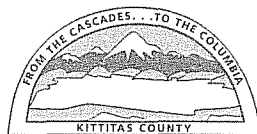

www.co.kittitas.wa.us/health/

Environmental
Health Services
411 North Ruby Street, Suite 3
Ellensburg, WA 98926
T: 509.962.7698
F: 509.962.7052



To Protect and Promote the Health and the Environment of the People of Kittitas County

install a septic system on the property. ***Since the type of soil and water source supplying the property can ultimately determine the minimum lot size, it is recommended that soil logs be conducted early in the plat planning process.***

At this time the application does not contain sufficient information to make a determination of adequate soil assessment and water availability. The above mentioned items need to be submitted to the Public Health Department in order for the plat application to be recommended for final approval.

If you should have any further questions please don't hesitate to contact me by phone 509-962-7580 or email: holly.duncan@co.kittitas.wa.us

Sincerely,

A handwritten signature in cursive script that reads "Holly Duncan".

Holly Duncan

Environmental Health Specialist II

Kittitas County
Public Health Department
507 N. Nanum Street, Suite 102
Ellensburg, WA 98926
T: 509.962.7515
F: 509.962.7581

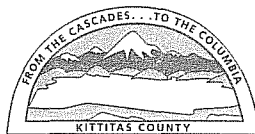

www.co.kittitas.wa.us/health/

Environmental
Health Services
411 North Ruby Street, Suite 3
Ellensburg, WA 98926
T: 509.962.7698
F: 509.962.7052

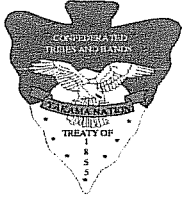

Confederated Tribes and Bands of the Yakama Nation
Established by the Treaty of June 9, 1855

Post Office Box 151
Toppenish Washington 98948

RECEIVED

JAN 20 2009

Kittitas County
CDS

Allison Kimball
Kittitas County Community Development Services
411 N. Ruby St, Suite 2
Ellensburg, WA 98926

January 14, 2009

Subject: O. Sieber Short Plat (SP-08-00052)

Dear Ms. Kimball,

Thank you for contacting the Yakama Nation Cultural Resource Program regarding the proposed development listed above. This project falls within the ceded lands of the Yakama Nation, defined as the usual and accustomed areas and places utilized by the ancestors of the Yakama People for the gathering of foods, medicines, and ceremonial purposes. These legal rights are outlined in the Treaty of 1855 between the Yakama Nation and the United States government. Just as in the past, these lands and their resources continue to fulfill a central role in the culture of members of the Yakama Nation in the present, and will continue to do so in the future.

The provided project documentation notes the proposed development as being a 3-lot short plat on approximately 17.65 acres of land located north of Burbank Creek Road, off of Arrowhead Road within portions of Sections 21 and 22, Township 15 N., Range 19 E. We have reviewed the project in terms of its potential for adverse impacts to environmental resources, sacred areas, traditional cultural properties, archaeological properties and associated cultural issues. It is our belief that the proposed project is occurring within an area which has an extremely high potential for cultural sites and other cultural resources. The Burbank Creek Valley is well known to the Yakama Nation as a place of resource gathering, homesites, as well as burial sites and places of spiritual significance.

A review of the Washington State Department of Archaeology and Historic Preservation (DAHP) cultural site database indicates the rich cultural history of the area, with 22 previously recorded archaeological sites and isolated artifacts being found within 1-mile of the subject property.

Given the potential for cultural resource sites at the proposed development locale, we feel that the appropriate action to identify any cultural/archaeological sites present should begin with a professional cultural resources survey and historical documentation of the property prior to any ground disturbing activities associated with the short plat. Further, based on the findings of the survey, additional cultural resources protective measures may be necessary during any type of ground disturbing activities relating to development.

Please contact me at 1-509-865-5121 ext. 4737 or tribal archaeologist Dave Woody at ext. 4760 if you have any questions regarding the above recommendation.

Sincerely,

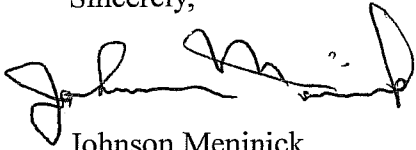
A handwritten signature in black ink, appearing to read 'Johnson Meninick', written over a horizontal line.

Johnson Meninick,
Yakama Nation Cultural Resources Program Manager

CC: Gretchen Kaehler, Assistant State Archaeologist, Washington State Department of Archaeology
and Historic Preservation (DAHP)

Kate Valdez, Yakama Nation Tribal Historic Preservation Officer (THPO)

To: Allison Kimball
Planner II

fax: 509 962-7682

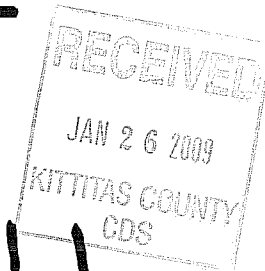

From: Margaret M Walsh

telephone 509 248-9937

RE: O. SIEBER

SHORT PLAT

SP-08-00052

pg 1 of 3

Jan 26, 2009

RE: O. SIEBER SHORT PLAT
SP-08-00052

1) As the GRANTOR of the DRAINFIELD EASEMENT recorded March 2006, and noted on SP-08-00052, I submit the following comment.

The DRAINFIELD EASEMENT was granted to:

KiH. CO. Ass TAX PARCEL

15-19-21000-0015 (243133)

The DRAINFIELD EASEMENT ^{ONLY!} was NOT granted to:

KiH CO Ass TAX PARCEL

15-19-22000-0014 (084133).

pg 2 of 3

2) The reference to ADJACENT OWNERS
TAX PARCEL ID # 15-19-22000-0031
(737431) Margaret Walsh
should read (737436).

Thank-you for your consideration.

M.M. Walsh
Margaret M. Walsh



To Protect and Promote the Health and the Environment of the People of Kittitas County

RECEIVED
NOV 25 2008
Kittitas County
CDS

November 20, 2008

Otto Sieber
470 Roza View Drive
Yakima, WA 98901

RE: O. Sieber Short Plat (SP-08-00052) submission fee received (\$380.00/receipt #3700)

Dear Otto Sieber:

We have received the application for your proposed Short Plat (located in the portion of the E ½ of the SE ¼ of Section 21 and a portion of the W ½ of the SW ¼ of Section 22, Township 15N, Range 19E.W.M., off of Hwy 97, Canyon Road).

Enclosed is a checklist and detailed instructions for completing the Environmental Health requirements.

Your plat application will not be approved until you meet the enclosed requirements.

Once we have received and reviewed the required information, we will notify Community Development Services that you have satisfactorily addressed health department requirements.

If you have any questions or concerns, please feel free to contact our office.

Sincerely,

A handwritten signature in black ink that reads "Cathy Bambrick".

Cathy Bambrick, Public Health Administrator
Kittitas County Public Health Department

cc: Community Development Services, Encompass Engineering & Surveying
Enc: Checklist, Instructions for Completing EH Requirements, Soil Log Requirements

Kittitas County
Public Health Department
507 N. Nanum Street, Suite 102
Ellensburg, WA 98926
T: 509.962.7515
F: 509.962.7581

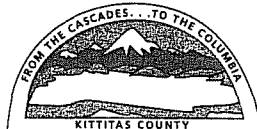

www.co.kittitas.wa.us/health/

Environmental
Health Services
411 North Ruby Street, Suite 3
Ellensburg, WA 98926
T: 509.962.7698
F: 509.962.7052

Checklist

Prior to receiving approval of the above listed plat you must meet WAC 246-272-205(1) and WAC 246-272-095(1) by:

1. Proving there is an adequate supply of potable water

*Choose and follow instructions for **one** of the five following options:*

Group “A” public well

Provide written approval from Washington State Department of Health

Group “B” public well

Schedule a well site inspection or site inspection with Public Health as the first step toward approval of a group B system (the Group B system must be approved prior to plat approval)

Individual wells

Provide a well log or hydrogeological report to prove adequate ground water exists for the proposed number of potable water wells (see page 4). If a well log is used provide potable water test results.

Shared two-party well

Submit existing well log and a water user’s agreement signed by both parties

Public utility water supply

Submit a signed letter of agreement from a public utility official

AND

2. Proving satisfactory sewage disposal

*Choose and follow instructions for **one** of the two following options:*

On-site sewage

You must schedule a soil log and prepare the site (dig holes)

Public utility sewer

You must submit a signed letter of agreement from the public utility official

Instructions for Completing Environmental Health Requirements

I. ADEQUATE POTABLE WATER SUPPLY:

PUBLIC UTILITY WATER SUPPLY APPLICANTS

Submit a signed letter of agreement with the responsible public utility official and the developer/owner, granting delivery of potable water for the entire development.

PUBLIC WATER SYSTEMS

All Public Water System applicants must contact a Satellite Management Agency (SMA) before initiating the application process. Evergreen Valley Utilities (509) 674-9642 and Lookout Mountain Utilities Management (509) 674-6989 are the current SMAs.

PUBLIC GROUP “A” WELL

If you have an existing well and a Department of Ecology issued “water right” for potable usage of the well, Washington State Department of Health (DOH) is the regulatory authority for approving Group A systems. We require written verification that DOH has approved the system prior to final plat approval (see contact information below). If you have not secured a water right for potable use you must contact the Washington State Department of Ecology (Central Region Office) located in Yakima, Washington to begin the process of obtaining a water right. Their contact number is: (509) 575-2800.

PUBLIC GROUP “B” WELLS

Washington State Department of Health and Kittitas County Public Health Department share the regulatory authority for approving Group B Water Systems in Kittitas County. The process for approval includes a source site inspection to approve the location of the proposed well or if the well exists to ensure that it meets the criteria for approval; drilling of the well and/or ensure that the well is located within the subdivision boundaries; completion of the well infrastructure, the workbook and all related documentation including testing and satisfactory results.

All Group B applications with **3-9 connections should be submitted to Kittitas County Public Health Department; all Group B applications **10-14 connections** should be submitted to Washington State Department of Health at the addresses provided below.

Kittitas County Public Health Department
Environmental Health Division
411 N. Ruby Street, Suite 3
Ellensburg, WA 98926
(509) 962-7698

Washington State Department of Health
1500 W. 4th, Suite 305
Spokane, WA 99204
(509) 456-2453
ATTN: Tom Justus, Regional Engineer

After all of the aforementioned information is submitted, reviewed, and approved by Washington State DOH, final issuance of the well ID number completes the requirement.

INDIVIDUAL WELLS

Submit well logs or a hydrogeological report with documentation/evidence to support the claim regarding adequate availability of groundwater for the proposed number of potable water wells. This report shall be submitted by a Professional Engineer who practices in the field of hydrology or by a licensed Hydrogeologist. According to Critical Areas Ordinance 17A.08.25, individual wells must be located 50 feet from all property lines. To obtain well logs, contact Department of Ecology at (509) 575-2490.

After July 8, 2008 all applicants for subdivision (short and long plats) utilizing wells shall have a note placed on the face of the final mylars that states:

“The approval of this division of land includes no guarantee that there is a legal right to withdraw groundwater within the land division. The approval of this division of land provides no guarantee that use of water under the ground water exemption (RCW 90.44.050) for this plat or any portion thereof will not be subject to curtailment by the Department of Ecology or a court of law. “

AND

“Metering will be required on all residential well connections and metering results shall be recorded in a manner consistent with Kittitas County and Washington State Department of Ecology requirements.”

II. SATISFACTORY SEWAGE DISPOSAL

PUBLIC UTILITY SEWER

Submit a signed letter of agreement between the responsible public utility official and the developer/owner or other documentation that provides proof of connection to public sewer.

ON SITE SEWAGE

Soil logs will need to be scheduled and dug at a mutually convenient time. The developer/owner shall provide soil logs as per WAC 246-272A or as amended (see attached soil log instruction sheet). The information obtained will be recorded and placed in the plat file for future reference. The information obtained from these soil logs is for plat approval purposes only and does not constitute a site evaluation in conjunction with the issuance of a permit for any specific lot.

SET BACK REQUIREMENTS

A well must be located 50 feet from a septic tank and 100 feet from a drain field.

Soil Log Requirements for Land Division

Purpose: The purpose of a soil log is to ensure that future property owners can be assured that they will be able to install a septic system on the property. A soil log is performed to



To Protect and Promote the Health and the Environment of the People of Kittitas County

RECEIVED
NOV 25 2008
Kittitas County
CDS

November 20, 2008

Otto Sieber
470 Roza View Drive
Yakima, WA 98901

RE: O. Sieber Short Plat (SP-08-00052) submission fee received (\$380.00/receipt #3700)

Dear Otto Sieber:

We have received the application for your proposed Short Plat (located in the portion of the E ½ of the SE ¼ of Section 21 and a portion of the W ½ of the SW ¼ of Section 22, Township 15N, Range 19E.W.M., off of Hwy 97, Canyon Road).

Enclosed is a checklist and detailed instructions for completing the Environmental Health requirements.

Your plat application will not be approved until you meet the enclosed requirements.

Once we have received and reviewed the required information, we will notify Community Development Services that you have satisfactorily addressed health department requirements.

If you have any questions or concerns, please feel free to contact our office.

Sincerely,

A handwritten signature in black ink that reads "Cathy Bambrick".

Cathy Bambrick, Public Health Administrator
Kittitas County Public Health Department

cc: Community Development Services, Encompass Engineering & Surveying
Enc: Checklist, Instructions for Completing EH Requirements, Soil Log Requirements

Kittitas County
Public Health Department
507 N. Nanum Street, Suite 102
Ellensburg, WA 98926
T: 509.962.7515
F: 509.962.7581

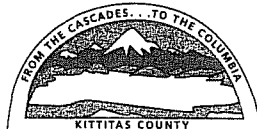

www.co.kittitas.wa.us/health/

Environmental
Health Services
411 North Ruby Street, Suite 3
Ellensburg, WA 98926
T: 509.962.7698
F: 509.962.7052

Checklist

Prior to receiving approval of the above listed plat you must meet WAC 246-272-205(1) and WAC 246-272-095(1) by:

1. Proving there is an adequate supply of potable water

*Choose and follow instructions for **one** of the five following options:*

Group “A” public well

Provide written approval from Washington State Department of Health

Group “B” public well

Schedule a well site inspection or site inspection with Public Health as the first step toward approval of a group B system (the Group B system must be approved prior to plat approval)

Individual wells

Provide a well log or hydrogeological report to prove adequate ground water exists for the proposed number of potable water wells (see page 4). If a well log is used provide potable water test results.

Shared two-party well

Submit existing well log and a water user’s agreement signed by both parties

Public utility water supply

Submit a signed letter of agreement from a public utility official

AND

2. Proving satisfactory sewage disposal

*Choose and follow instructions for **one** of the two following options:*

On-site sewage

You must schedule a soil log and prepare the site (dig holes)

Public utility sewer

You must submit a signed letter of agreement from the public utility official

Instructions for Completing Environmental Health Requirements

I. ADEQUATE POTABLE WATER SUPPLY:

PUBLIC UTILITY WATER SUPPLY APPLICANTS

Submit a signed letter of agreement with the responsible public utility official and the developer/owner, granting delivery of potable water for the entire development.

PUBLIC WATER SYSTEMS

All Public Water System applicants must contact a Satellite Management Agency (SMA) before initiating the application process. Evergreen Valley Utilities (509) 674-9642 and Lookout Mountain Utilities Management (509) 674-6989 are the current SMAs.

PUBLIC GROUP "A" WELL

If you have an existing well and a Department of Ecology issued "water right" for potable usage of the well, Washington State Department of Health (DOH) is the regulatory authority for approving Group A systems. We require written verification that DOH has approved the system prior to final plat approval (see contact information below). If you have not secured a water right for potable use you must contact the Washington State Department of Ecology (Central Region Office) located in Yakima, Washington to begin the process of obtaining a water right. Their contact number is: (509) 575-2800.

PUBLIC GROUP "B" WELLS

Washington State Department of Health and Kittitas County Public Health Department share the regulatory authority for approving Group B Water Systems in Kittitas County. The process for approval includes a source site inspection to approve the location of the proposed well or if the well exists to ensure that it meets the criteria for approval; drilling of the well and/or ensure that the well is located within the subdivision boundaries; completion of the well infrastructure, the workbook and all related documentation including testing and satisfactory results.

All Group B applications with **3-9 connections should be submitted to Kittitas County Public Health Department; all Group B applications **10-14 connections** should be submitted to Washington State Department of Health at the addresses provided below.

Kittitas County Public Health Department
Environmental Health Division
411 N. Ruby Street, Suite 3
Ellensburg, WA 98926
(509) 962-7698

Washington State Department of Health
1500 W. 4th, Suite 305
Spokane, WA 99204
(509) 456-2453
ATTN: Tom Justus, Regional Engineer

After all of the aforementioned information is submitted, reviewed, and approved by Washington State DOH, final issuance of the well ID number completes the requirement.

ensure that suitable depth and type of soil is present on the property prior to final plat approval.

Since the type of soil and water source supplying the property can ultimately determine the minimum lot size, it is recommended that soil logs be conducted early in the plat planning process.

Requirements: In order for a soil log to be conducted, test holes must meet specific criteria according to Washington Administrative Code (WAC), Kittitas County Code (KCC) and Labor and Industries safety standards.

- 1) A minimum of one soil log per lot shall be dug to a depth of six feet, unless an impermeable layer such as bedrock, hardpan clay, or the existing water table prevents such a depth from being obtained. In some instances, additional holes may be required to determine if the minimum standards for septic support are present on the lot.
- 2) The design of a test hole shall be sloped to four feet beneath surface, leveled and then dug down an additional two feet for a total depth of six feet (see the diagram below for reference). Such a test hole is designed to prevent possible injury as a result of the surrounding soil bank collapsing into the test hole and to grant the local health officer ease of access to the soil profile.
- 3) In order to sub-divide property at least twelve inches of native, suitable soil must be present at the time the soil log is performed.
- 4) A soil log does not constitute a site-evaluation. A site evaluation determines the type of septic system required. A soil log only determines whether soils present on the property can support a septic system.

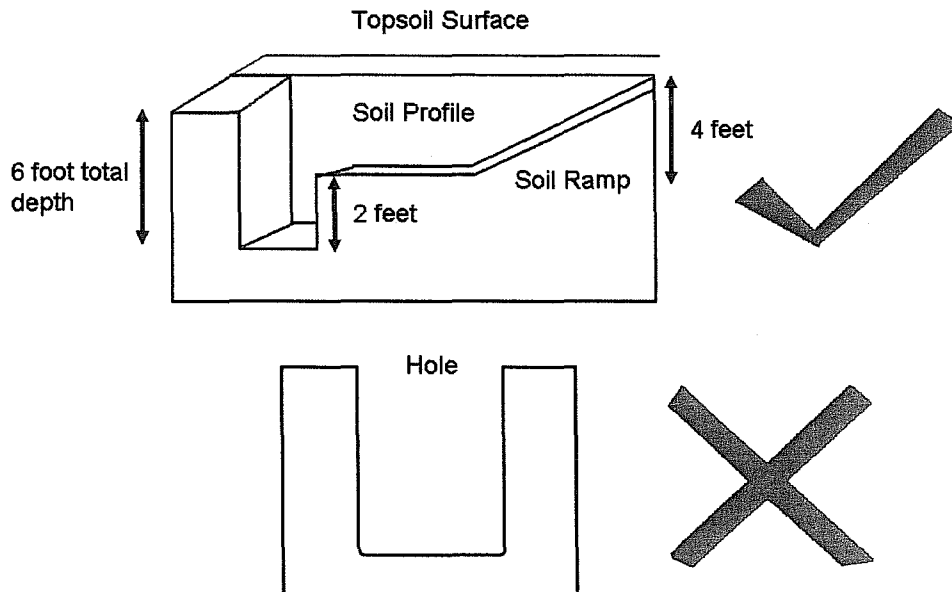

Minimum Land Area Requirements: According to the WAC 246-272 the minimum land area requirement from a public health perspective for subdivision of property is determined by the source of the drinking water and the soil type present to support an on-site sewage system (Table X). These guidelines have been put in place to protect human health and the environment from the potential health hazards that an on-site sewage system imposes. The type of water source available and soil type present must be determined by the local health officer. However, other minimum land area requirements may be subject to local government zoning regulations and restrictions, and it is advisable that property land owners seek advice from Community Development Services at (509) 962-7506 for assistance in this area.

TABLE X
Minimum Land Area Requirement
Single-Family Residence or Unit Volume of Sewage

| Type of Water Supply | Soil Type (defined by WAC 246-272A-0220) | | | | | |
|-------------------------|--|----------------|----------------|----------------|----------------|----------------|
| | 1 | 2 | 3 | 4 | 5 | 6 |
| Public | 0.5 acre | 12,500 sq. ft. | 15,000 sq. ft. | 18,000 sq. ft. | 20,000 sq. ft. | 22,000 sq. ft. |
| | 2.5 acre ¹ | | | | | |
| Individual, on each lot | 1.0 acre | 1 acre | 1 acre | 1 acre | 2 acres | 2 acres |
| | 2.5 acres ¹ | | | | | |

¹ See WAC 246-272A-0234(6).

Other Considerations: Since open holes present a potential danger to people, livestock, wild animals, and vehicles, it is advisable that such a hole be roped off or covered to prevent unwanted entry or marked to caution and facilitate finding. After the soil log has been performed the hole may be filled in by the property owner or contractor to eliminate the potential hazard.

Scheduling a soil log: Currently, soil logs are performed on a weekly basis by an Environmental Health Specialist. To schedule a soil log please contact the Environmental Health Office at 411 N. Ruby Street (509) 933-8261 to arrange an appointment.